

## Technical Data

### Enclosure

Material: Aluminium  
 Powder coated  
 RoHs: conform  
 Colour: silver grey,  
 RAL 7001  
 Dim. (LxWxH): **160x160x90 mm**  
 Weight: 1410 g (empty)  
 Protection: IP 65  
 Gasket: Temperature  
 resistant silicone  
 Lid screws: stainless steel  
 Storage  
 temperature: -50°C up to +80°C

### Junction Box

**Type: A21-E2-01609**  
 Type of protection: II 2G Ex e[ia] IIC T4/T6  
 II 2D Ex tD A21 IP65 T80°C  
 Certificate: TPS 07 ATEX 61951 1  
 Ambient  
 temperature: -50°C up to +60°C  
 Standards in use: IEC EN 60079-0  
 IEC EN 60079-7  
 IEC EN 61241-0  
 IEC EN 61241-1  
 Documentation:  
 CE Declaration: A21-E2-C0001  
 Manual: A21-E2-B0001

### Maximum number of threaded holes

	M16x1,5	M20x1,5	M25x1,5	M32x1,5	M40x1,5	M50x1,5	M63x1,5
face A/B	9	6	4	2	2	1	0
face C/D	4	3	2	2	0	0	0

### Maximum number of terminals

Cross section	2,5 mm <sup>2</sup>	4 mm <sup>2</sup>	6 mm <sup>2</sup>	10 mm <sup>2</sup>	16 mm <sup>2</sup>	35 mm <sup>2</sup>
Quantity	22	18	13	11	9	0

### Dimension drawing

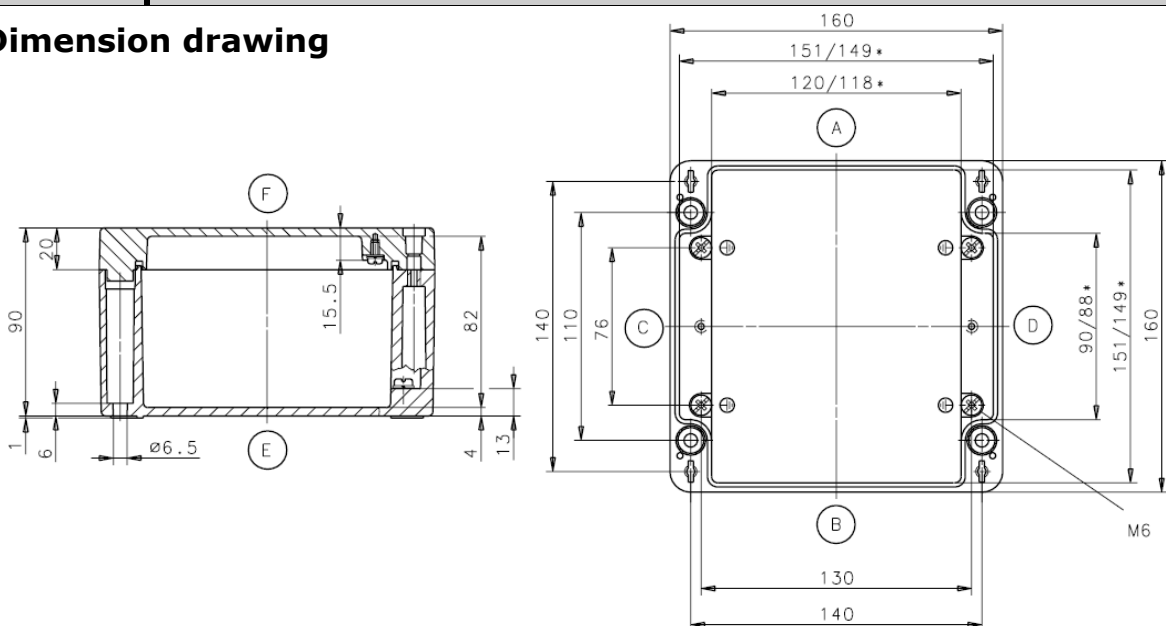

\*smaller dimension at the height of the mounting plate