

Technical Data

Enclosure

Material: Aluminium
 Powder coated
 RoHs: conform
 Colour: silver grey,
 RAL 7001
 Dim. (LxWxH): **122x120x90 mm**
 Weight: 920 g (empty)
 Protection: IP 65
 Gasket: Temperature
 resistant silicone
 Lid screws: stainless steel
 Storage
 temperature: -50°C up to +80°C

Junction Box

Type: A21-E2-01209
 Type of protection: II 2G Ex e[ia] IIC T4/T6
 II 2D Ex tD A21 IP65 T80°C
 Certificate: TPS 07 ATEX 61951 1
 Ambient
 temperature: -50°C up to +60°C
 Standards in use: IEC EN 60079-0
 IEC EN 60079-7
 IEC EN 61241-0
 IEC EN 61241-1
 Documentation:
 CE Declaration: A21-E2-C0001
 Manual: A21-E2-B0001

Maximum number of threaded holes

	M16x1,5	M20x1,5	M25x1,5	M32x1,5	M40x1,5	M50x1,5	M63x1,5
face A/B	6	4	2	2	1	0	0
face C/D	2	2	1	0	0	0	0

Maximum number of terminals

Cross section	2,5 mm ²	4 mm ²	6 mm ²	10 mm ²	16 mm ²	35 mm ²
Quantity	15	13	9	7	0	0

Dimension drawing

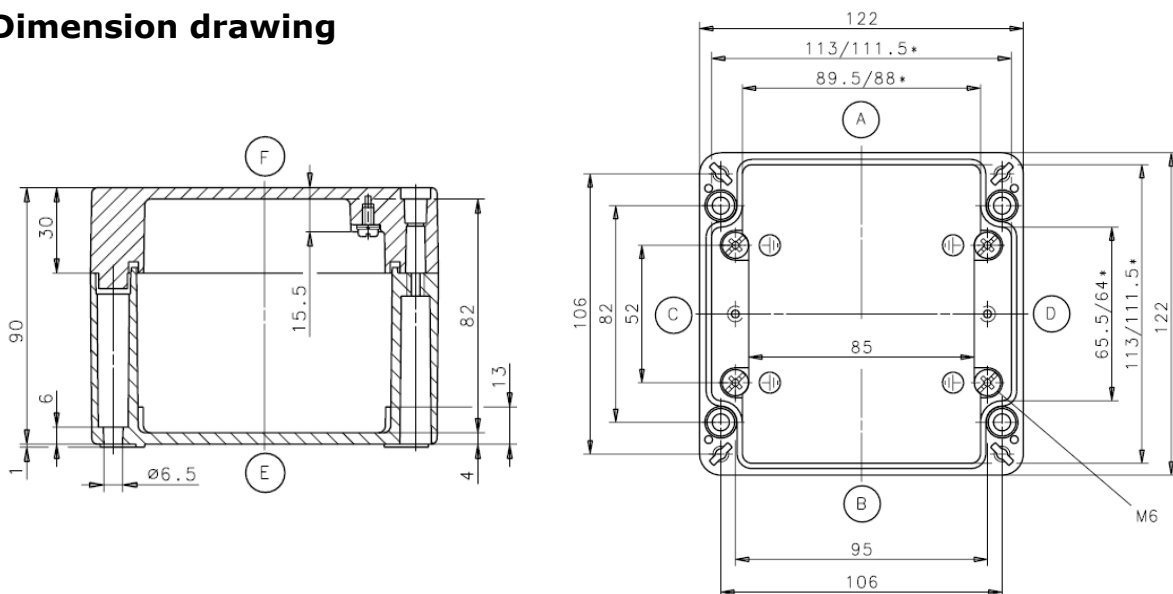

*smaller dimension at the height of the mounting plate