

Technical Data

Enclosure

Material: Aluminium
Powder coated
RoHs: conform
Colour: silver grey,
RAL 7001
Dim. (LxWxH): **125x80x57 mm**
Weight: 435 g (empty)
Protection: IP 65
Gasket: Temperature
resistant silicone
Lid screws: stainless steel
Storage
temperature: -50°C up to +80°C

Junction Box

Type: A21-E2-01306
Type of protection: II 2G Ex e[ia] IIC T4/T6
II 2D Ex tD A21 IP65 T80°C
Certificate: TPS 07 ATEX 61951 1
Ambient
temperature: -50°C up to +60°C
Standards in use: IEC EN 60079-0
IEC EN 60079-7
IEC EN 61241-0
IEC EN 61241-1
Documentation:
CE Declaration: A21-E2-C0001
Manual: A21-E2-B0001

Maximum number of threaded holes

	M16x1,5	M20x1,5	M25x1,5	M32x1,5	M40x1,5	M50x1,5	M63x1,5
face A/B	4	3	2	0	0	0	0
face C/D	2	1	0	0	0	0	0

Maximum number of terminals

Cross section	2,5 mm ²	4 mm ²	6 mm ²	10 mm ²	16 mm ²	35 mm ²
Quantity	17	0	0	0	0	0

Dimension drawing

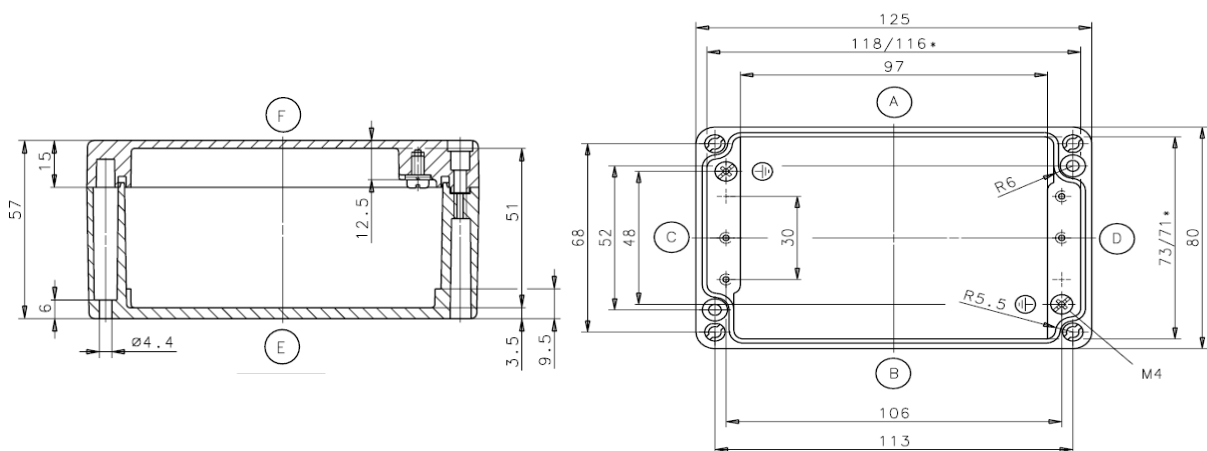

*smaller dimension at the height of the mounting plate