

Technical Data

Enclosure

Material: Fibre glass reinforced Polyester conform
 RoHs: conform
 Colour: black, RAL 9005
 Dim. (LxWxH): **255x250x120 mm**
 Weight: 2650 g (empty)
 Protection: IP 65
 Gasket: Temperature resistant silicone
 Lid screws: stainless steel
 Storage temperature: -50°C up to +80°C

Junction Box

Type: A21-E1-02612
 Type of protection: II 2G Ex e[ia] IIC T4/T6
 II 2D Ex tD A21 IP65 T80°C
 Certificate: TPS 07 ATEX 61951 1
 Ambient temperature: -50°C up to +60°C
 Standards in use: IEC EN 60079-0
 IEC EN 60079-7
 IEC EN 61241-0
 IEC EN 61241-1
 Documentation:
 CE Declaration: A21-E1-C0001
 Manual: A21-E1-B0001

Maximum number of threaded holes

	M16x1,5	M20x1,5	M25x1,5	M32x1,5	M40x1,5	M50x1,5	M63x1,5
face A/B	23	17	11	7	4	3	3
face C/D	14	10	8	4	3	2	2

Maximum number of terminals

Cross section	2,5 mm ²	4 mm ²	6 mm ²	10 mm ²	16 mm ²	35 mm ²
Quantity	80	66	25	20	16	12

Dimension Drawing

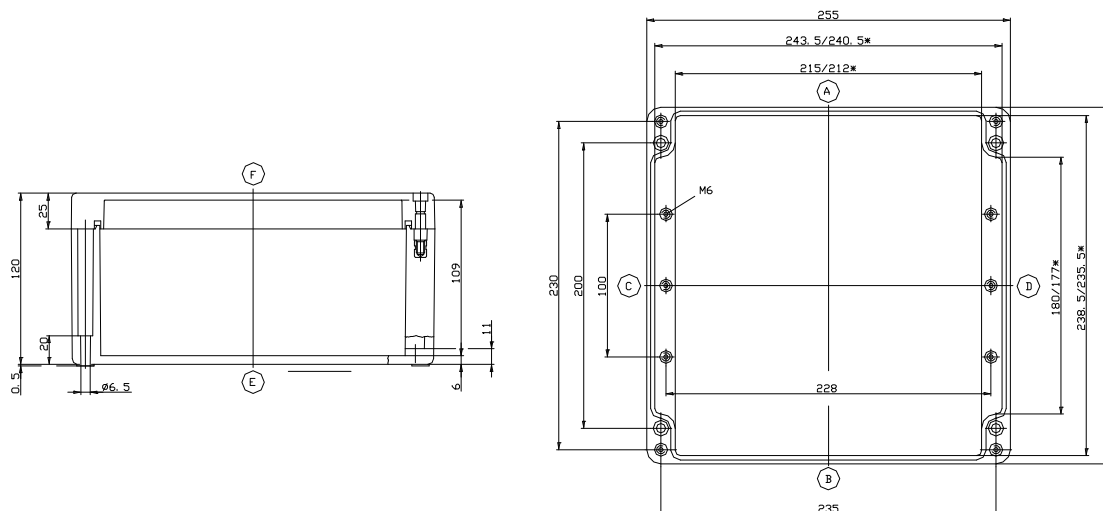

* smaller dimension at the height of the mounting plate