

Technical Data

Enclosure

Material: Fibre glass reinforced Polyester
 RoHs: conform
 Colour: black, RAL 9005
 Dim. (LxWxH): **122x120x90 mm**
 Weight: 750 g (empty)
 Protection: IP 65
 Gasket: Temperature resistant silicone
 Lid screws: stainless steel
 Storage temperature: -50°C up to +80°C

Junction Box

Type: A21-E1-01209
 Type of protection: II 2G Ex e[ia] IIC T4/T6
 II 2D Ex tD A21 IP65 T80°C
 Certificate: TPS 07 ATEX 61951 1
 Ambient temperature: -50°C up to +60°C
 Standards in use: IEC EN 60079-0
 IEC EN 60079-7
 IEC EN 61241-0
 IEC EN 61241-1
 Documentation:
 CE Declaration: A21-E1-C0001
 Manual: A21-E1-B0001

Maximum number of threaded holes

	M16x1,5	M20x1,5	M25x1,5	M32x1,5	M40x1,5	M50x1,5	M63x1,5
face A/B	5	4	3	2	1	0	0
face C/D	3	2	2	1	0	0	0

Maximum number of terminals

Cross section	2,5 mm ²	4 mm ²	6 mm ²	10 mm ²	16 mm ²	35 mm ²
Quantity	16	13	10	6	0	0

Dimension drawing

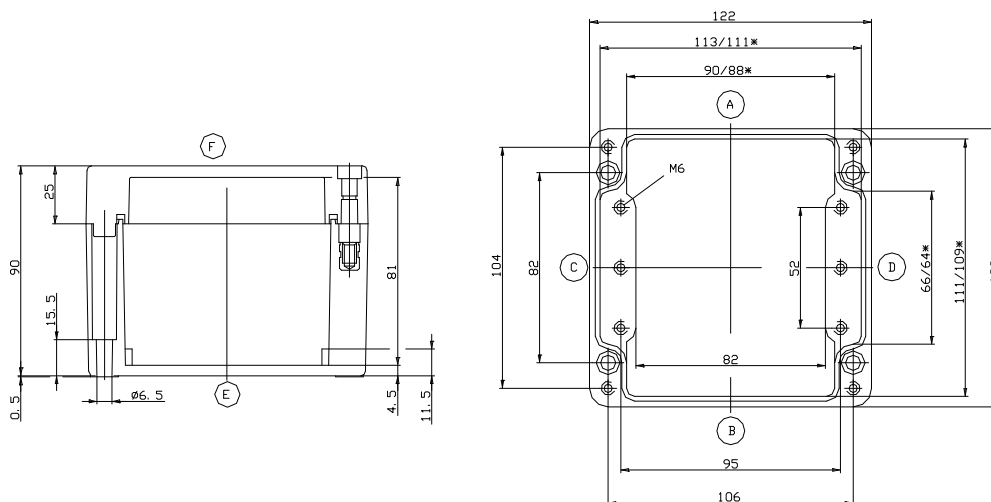

*

smaller dimension at the height of the mounting plate